

Main Product Category

Tube Fittings
Pipe Fittings
PTC fittings
Needle Valve
Ball Valve

Valve Manifolds
Monoflange Valve
Block and Bleed Valves
Grease Fitting
Check Valve

Air Header
Condensate Pot
Sample cylinder
Syphon
Snubber

Instrumentation tube & Pipe fittings

Size Tube(OD): 1/16" to 2" (2mm to 38mm)

Size for pipe end connection: 1/8" to 2"(NPT,BSPT,BSPP...)

Raw material:SS316/L,SS304,Brass,Monel,Alloy 20,Inconel,Hatelloy,Titanium...)

Male connector



Female connector



Union



Bulkhead Union



Male elbow



Female elbow



Union elbow



Cross



Union Tee



Reducing Union Tee



Male run Tee



Male Branch Tee



Nut



Bulkhead locknut



Front ferrule



Back ferrule



Cap and Plug



JIC Adapter

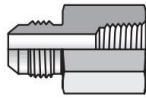

Hollow Hex pipe plug



Hollow Hex plug



Hex Nipple



Adapter



Hex Coupling



Male Tee



Male elbow



Female elbow



Female Tee



Cross

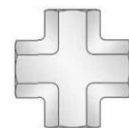

PTC fittings

Size Tube(OD): 1/16" to 2" (3mm to 16mm)

Size for pipe end connection: 1/8" to 1/2" (NPT, BSPT, BSPP(G), Metric, UNF...)

Raw material: SS316/L, SS304, Brass...)

Straight-Male



Straight-Female



Straight-Bulkhead



Straight-Union



Straight-Bulkhead Union



Elbow-Male



Elbow-Female



Elbow-Union



Tee-Street Male



Tee-Branch Male



Tee-Union



Tee-Y type Union



Speed Connector



SS Silencer



Manifold



Nylon, PU, PTFE Tubing



Needle valves

Size Tube(OD): 1/8" to 1" (6mm to 25mm)

Size for pipe end connection: 1/8" to 2" (NPT, BSPT, BSPP...)

Raw material: SS316/L, SS304, Monel, Alloy 20, Inconel, Hastelloy, Titanium...

Integral-Bonnet Needle Valves

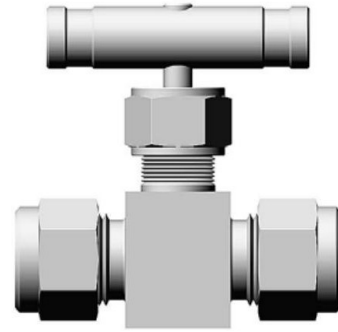
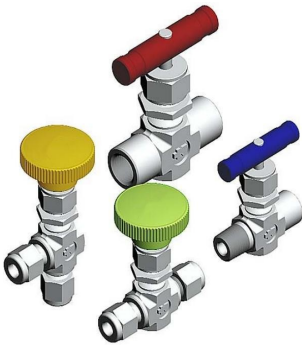

Severe Service Union Bonnet Needle Valve

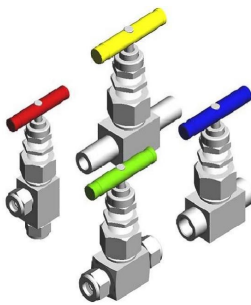

General Utility Service Needle Valves

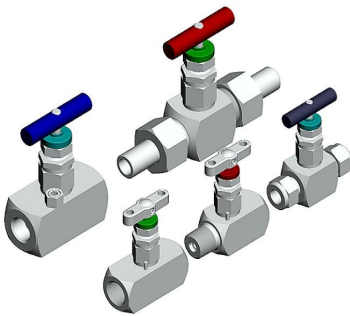

Gauge Valves

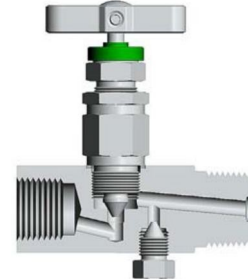
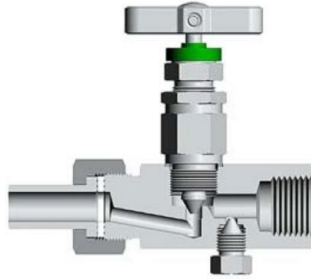
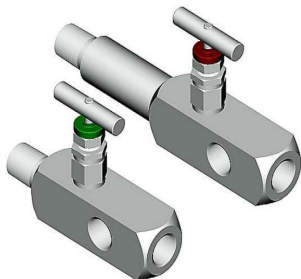

Ball valves

Size Tube(OD): 1/8" to 1" (6mm to 25mm)





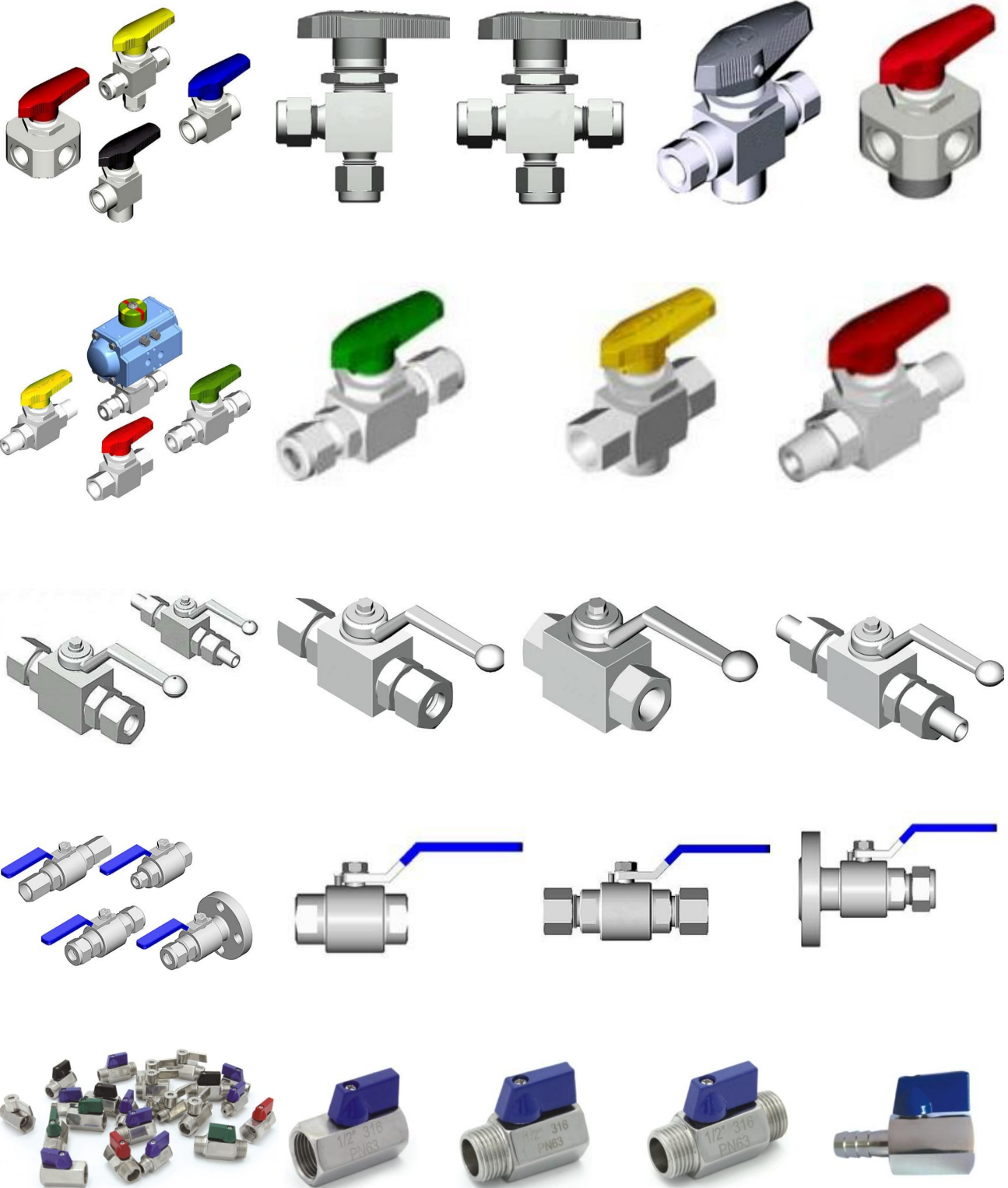



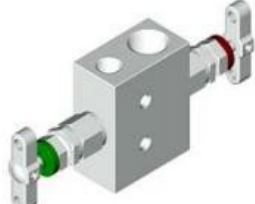

Size for pipe end connection: 1/8" to 2" (NPT, BSPT, BSPP...)

Raw material: SS316/L, SS304, Brass, Monel, Alloy 20, Inconel, Hatelloy, Titanium...







Instrument manifolds

2 way manifolds

-GV-8M 8F -GV-8F8M 	-2BZ-4F4F -2BZ-8F8F 	-2BI-4F4F -2BI-8F8F 	-2BL I -4F4F -2BL I -8F8F 
-2BL II -4F4F -2BL II -8F8F 	-2BV I -4FFL -2BV I -8FFL 	-2BV II -4F4F -2BV II -8F8F 	-2BV III -4FFL -2BV III -8FFL 
-2BV IV -4FFL -2BV IV -8FFL 	-2TL-6FFL -2TL-8FFL 	-2TI-6FFL -2TI-8FFL 	

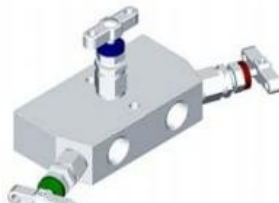
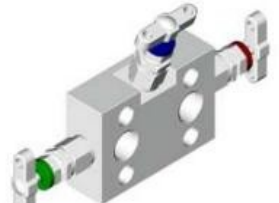
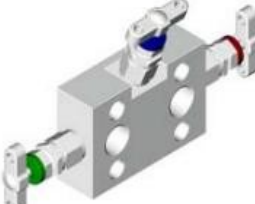
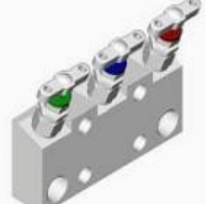
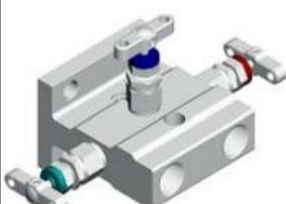
3 way manifolds

-3BT-4F4F -3BT-8F8F 	-3BT I -4F4F -3BT I -8F8F 	-3BTV-4F4F -3BTV-8F8F 	-3BTV.33-4FFL -3BTV.33-8FFL 
-3BTV-4FFL -3BTV-8FFL 	-3BIV-4FFL -3BIV-8FFL 	-3TI-4FFL -3TI-8FFL 	-3HI-FL -3HI-FL 

3 way manifolds

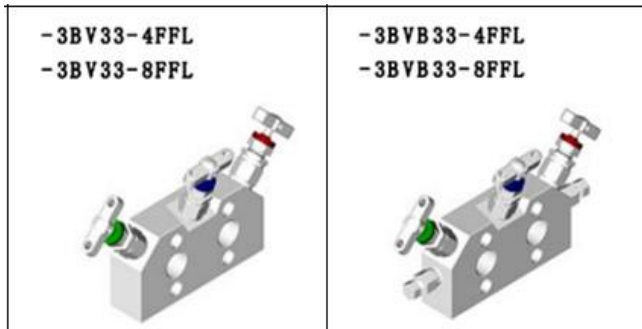

5 way manifolds

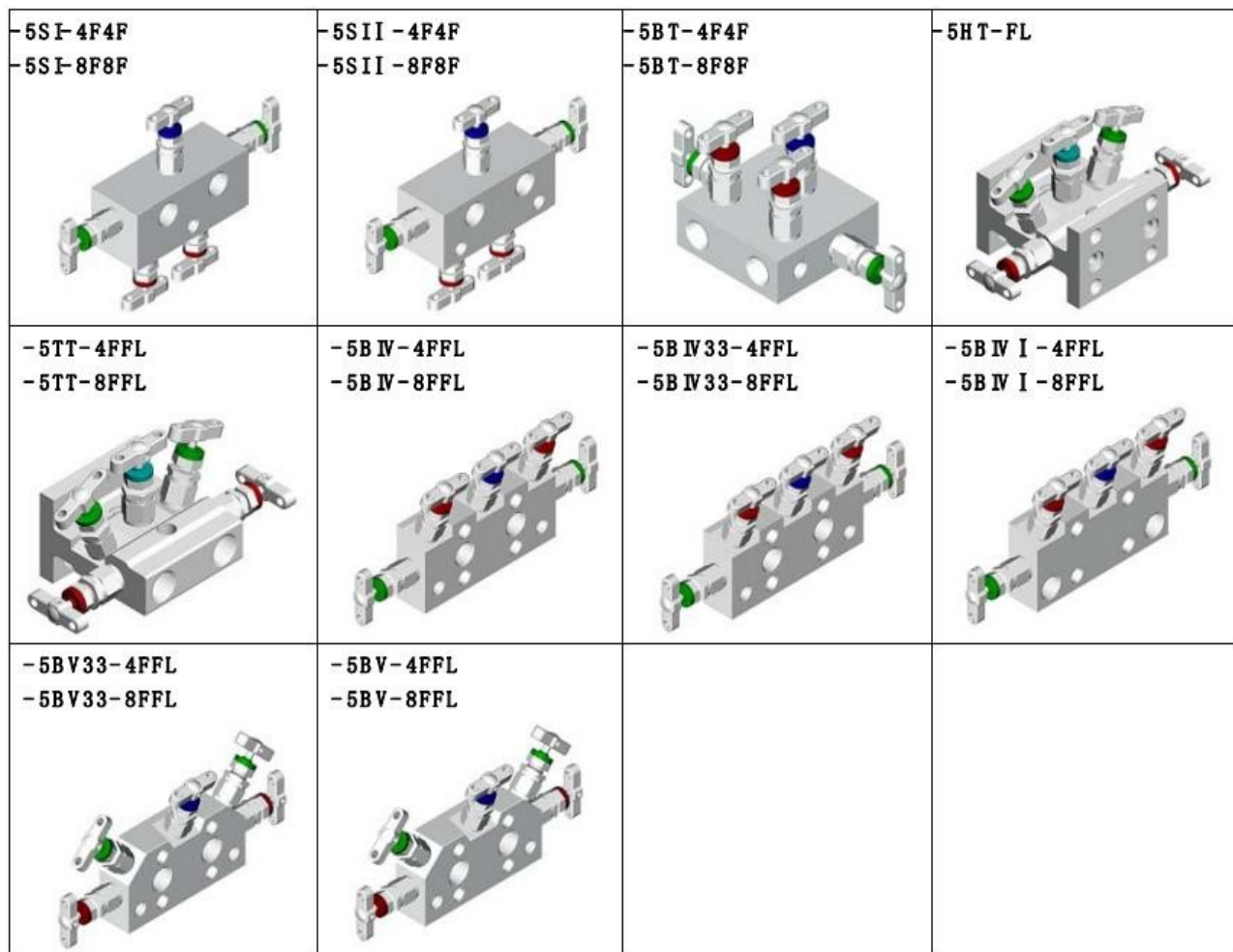

Monoflange valves, Block and bleed valves

Size for flange end connection: 1/2" to 4" & 150# to 2500#

Size for pipe end connection: 1/4" to 1" (NPT, BSPT, BSPP...)

Raw material: SS316/L, SS304, Brass, Monel, Alloy 20, Inconel, Hastelloy, Titanium...

Monoflange valves

SB series
Single block



SBB series
Block&Bleed

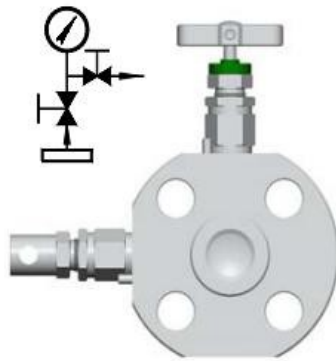

DBB series **Block**
Block Bleed

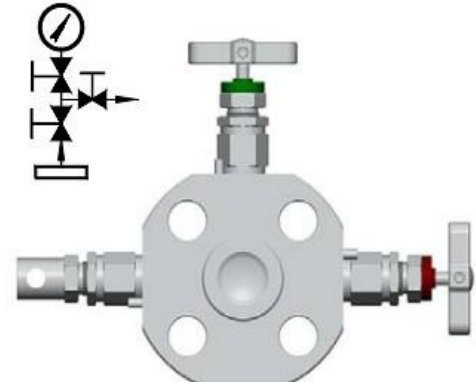

Block and bleede ball valve

Single block and
bleede ball valve

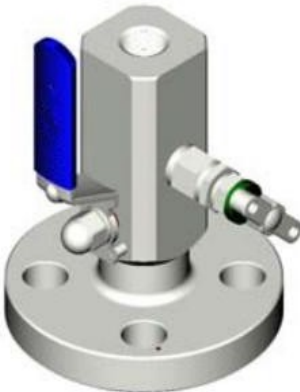

Double block and
bleede ball valve

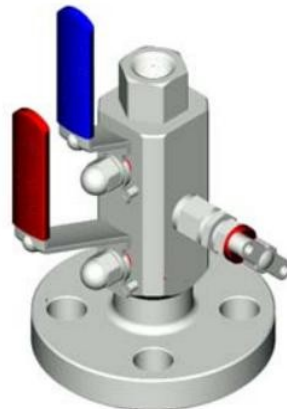

Double block and
bleede ball valve

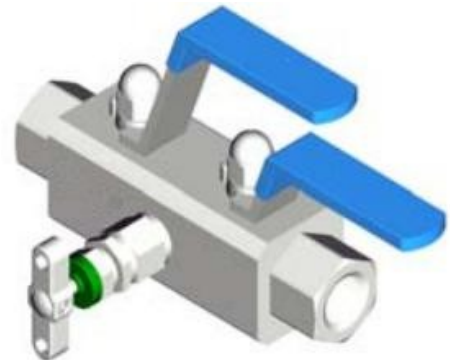

Modular construction
Flange*Flange

Process interface valves



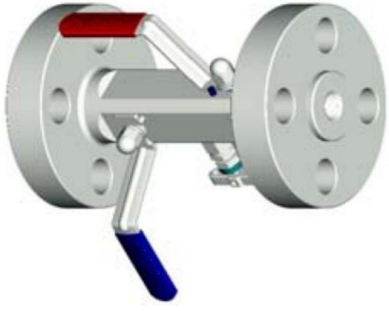

Grease fittings

Size for pipe end connection: 1/4" to 1"

Raw material: SS316/L, SS304, Monel, Alloy 20, Inconel, Hastelloy, Titanium...

Pressure: 6000PSI, 10000PSI, 15000PSI, 20000PSI

Vented Cap Body Grease Fittings with Giant Button



Free Flow Vented Cap Body Grease Fittings with Giant Button Head

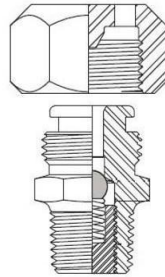

Vented Cap Body Grease Fittings without Giant Button



Free Flow Vented Cap Body Grease Fittings without Giant Button

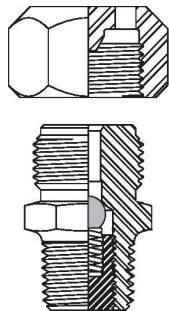

Lubrication (Sealant) Packing Injection Fitting 9/16" Autoclave Style

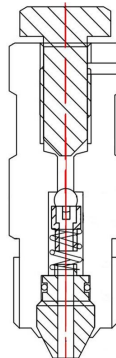

Lubrication (Sealant) Fitting 9/16" Autoclave Style



Leak locker fitting Gaint button head

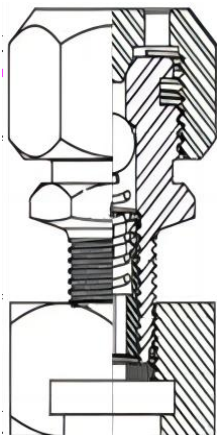

Packing Injection Fittings (Floating Ball-Taper Cavity)



Free Flow Packing Injection Fittings

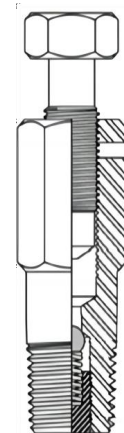

Grease fittings

Size for pipe end connection: 1/4" to 1"

Raw material: SS316/L, SS304, Monel, Alloy 20, Inconel, Hastelloy, Titanium...

Pressure: 6000PSI, 10000PSI, 15000PSI, 20000PSI

Grease Injection Fitting



Combination Lube Adapter

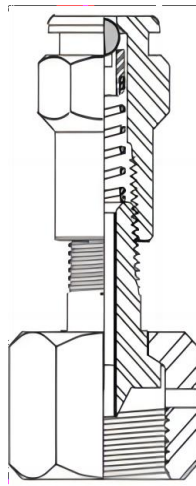

Gaint button head fitting --Double ball

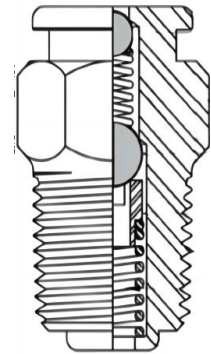

Gaint button head fitting-Single ball

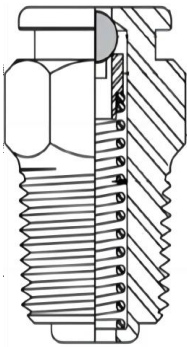

Lock Seal Fitting – Double Check

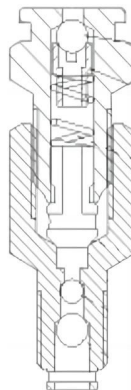

Internal Check Valve Single Ball, Soft Seat, Spring Based

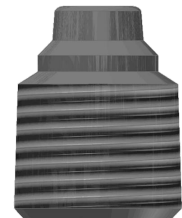

Body Vent (Bleeder) fitting Standard HexHead Style



Body Vent (Bleeder) fitting Hex Socket Head Style

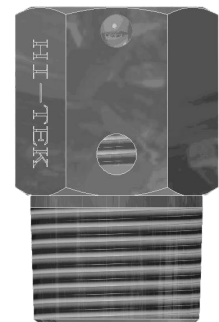

Check valves

Male to Male

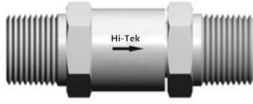

Double ferrules



Butt weld

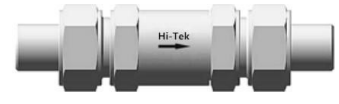

Female to Female



Female to Female



Male to Female



Instrumentation accessories

Condensate Pot



Pipe Syphon



Snubber

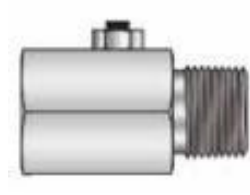

Air distributor

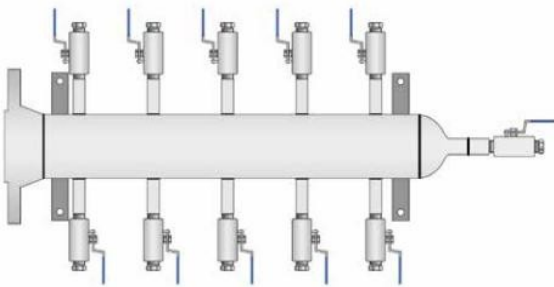

Sample cylinder

